

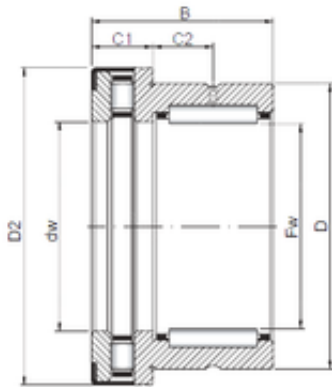

NTN BEARUNG DRIVESHAFT,INC.

25 mm x 37 mm x 30 mm ISO NKXR 25 Z
complex bearings



Bearing No. NKXR 25 Z

Size	25x37x30 mm
Bore Diameter	25 mm
Outer Diameter	37 mm
Width	30 mm
d	25 mm
Fw	25 mm
D	37 mm
B	30 mm
C1	11 mm
D2	43,2 mm
C2	9,5 mm

NKXR 25 Z Bearing 2D drawings and 3D CAD models